

# **Cleaning Instructions**

**Tektronix**

**Phaser™ 200 Series  
Color Printers**

Copyright © 1995 by Tektronix, Inc., Wilsonville, Oregon. Printed in the United States of America.  
All rights reserved. Contents of this publication may not be reproduced in any form without permission of Tektronix, Inc.

This instrument, in whole or in part, may be protected by one or more U.S. or foreign patents or patent applications. Information provided upon request from Tektronix, Inc., P.O. Box 1000, Wilsonville, Oregon 97070-1000.

If acquired subject to FAR or DFARS, the following shall apply:

- Unpublished — rights reserved under the copyright laws of the United States.
- Restricted Rights Legend — Use, duplication, or disclosures by the U.S. government is subject to restrictions as set forth in subparagraph (c)(1)(ii) of the Rights in Technical Data and Computer Software clause at DFARS 252.227-7013, or in subparagraph (c) (2) of the Commercial Computer Software – Restricted Rights clause at FAR 52.227-19, as applicable. Tektronix, Inc., P.O. Box 1000, Wilsonville, Oregon 97070-1000.

Tektronix® is a registered trademark of Tektronix, Inc. Phaser™ is a trademark of Tektronix, Inc. for color printers and related products.

Other marks are trademarks or registered trademarks of the companies with which they are associated.

## Users safety summary

**Terms in manual:** CAUTION Conditions that can result in damage to the product.  
WARNING Conditions that can result in personal injury or loss of life.

**Power source:** Do not apply more than 250 volts RMS between the supply conductors or between either supply conductor and ground. Use only the specified power cord and connector. Refer to a qualified service technician for changes to the cord or connector.

**Operation of product:** Avoid electric shock by contacting a qualified service technician to replace fuses inside the product. Do not operate without the covers and panels properly installed. Do not operate in an atmosphere of explosive gases.

WARNING Turning the power off using the On/Off switch does not de-energize the printer. You must remove the power cord to disconnect the printer from the mains. Keep the power cord accessible for removal in case of an emergency.

**Safety instructions:** Read all installation instructions carefully before you plug the product into a power source.

**Terms on product:** CAUTION A personal injury hazard exists that may not be apparent. For example, a panel may cover the hazardous area. Also applies to a hazard to property including the product itself.

DANGER A personal injury hazard exists in the area where you see the sign.

**Care of product:** Disconnect the power plug by pulling the plug, not the cord. Disconnect the power plug if the power cord or plug is frayed or otherwise damaged, if you spill anything into the case, if product is exposed to any excess moisture, if product is dropped or damaged, if you suspect that the product needs servicing or repair, and whenever you clean the product.

**Ground the product:** Plug the three-wire power cord (with grounding prong) into grounded AC outlets only. If necessary, contact a licensed electrician to install a properly grounded outlet.

Symbols as marked on product:

DANGER high voltage:



Protective ground (earth) terminal:



Use caution. Refer to the manual(s) for information:



**WARNING:** If the product loses the ground connection, usage of knobs and controls (and other conductive parts) can cause an electrical shock. Electrical product may be hazardous if misused.

# Contents

<i>Introduction</i> . . . . .	.1
<i>Thermal Head.</i> . . . .	.3
<i>Paper-feed Rollers</i> . . . . .	.5
<i>Paper-pick Rollers</i> . . . . .	.6
<i>Transfer Roll Sensor Pad</i> . . . . .	10
<i>Drum</i> . . . . .	11
<i>Exit Rollers.</i> . . . .	12

# Keeping your printer a top performer

## Introduction

By performing regular cleaning, you ensure that your printer produces the highest quality prints. Regular cleaning also helps prevent paper jams, smudged or streaked prints and misregistration.

Cleaning the printer is easy; just follow the procedures given in the next few pages.

## When to clean

Every time you replace the transfer roll, and whenever printing appears streaked, or media feeds improperly, clean these parts:

1. Thermal head
2. Paper-feed rollers
3. Paper-pick rollers

Clean these printer parts every 5,000 prints:

1. Transfer roll sensor pad
2. Drum
3. Exit rollers

## Troubleshooting

<b>Problem</b>	<b>Possible Solution</b>
Vertical streaks on prints.	Clean the thermal head.
Missing areas of primary colors (cyan, magenta, yellow, black).	Clean the thermal head.
Smudges on one end of prints.	Clean the paper-pick rollers.
Smudges throughout prints.	Clean the paper-feed rollers and exit rollers.

## Important notes about cleaning

- ❑ Use isopropyl alcohol to clean your printer. It can be purchased at your local pharmacy. You can also use cleaning wipes that are pre-saturated with isopropyl alcohol (Tektronix order number 006-7824-00).
- ❑ 90% isopropyl alcohol is recommended. If you use alcohol that is less than 90% pure, allow extra time for the paper-feed, paper-pick and exit rollers to dry.
- ❑ Before cleaning any part except the paper-pick rollers: Dampen a lint-free wipe with isopropyl alcohol.

## Cleaning kit

A cleaning kit is shipped with the printer (Tektronix order number 016-1233-00). You will need the contents of the cleaning kit to perform the cleaning procedures on the next few pages:

1. Lint-free cleaning wipes
2. A plastic bottle for isopropyl alcohol
3. A cleaning tray for cleaning paper-pick rollers
4. Cleaning Instructions (this book)

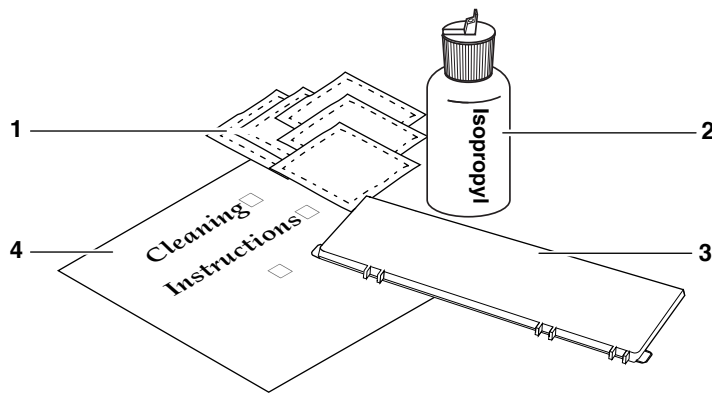

*Thermal Head – Clean every transfer roll change.*

□

**1**

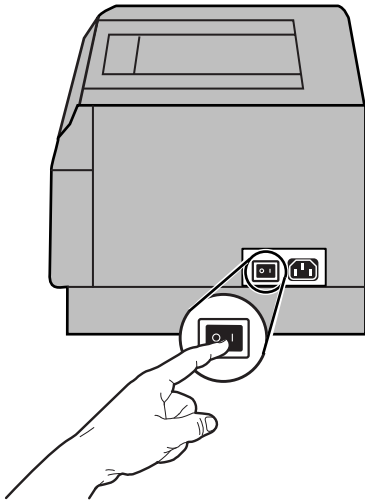

- Turn off the printer using the switch on the side.

**2**

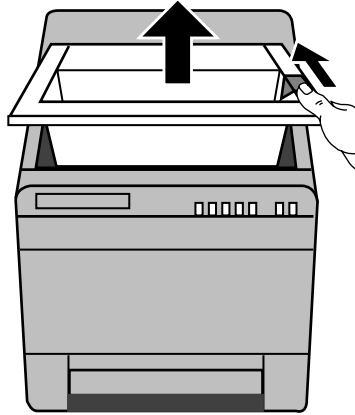

- Open the top cover.

**3**

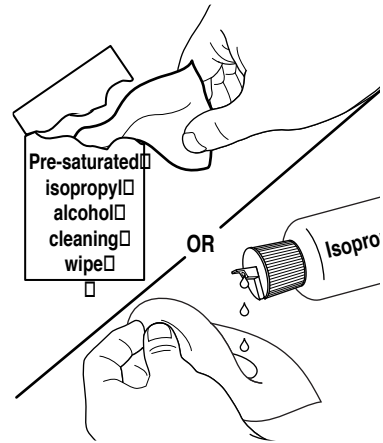

- Open a pre-saturated cleaning wipe packet and remove the wipe *or* dampen a lint-free wipe with isopropyl alcohol.



4

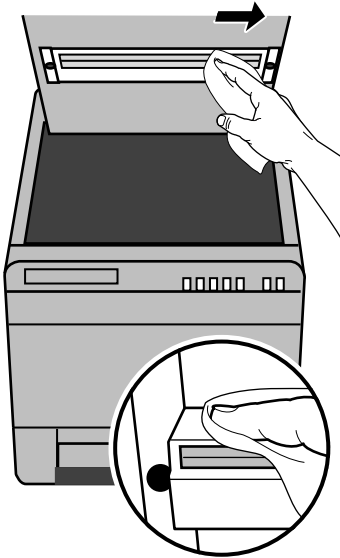

5

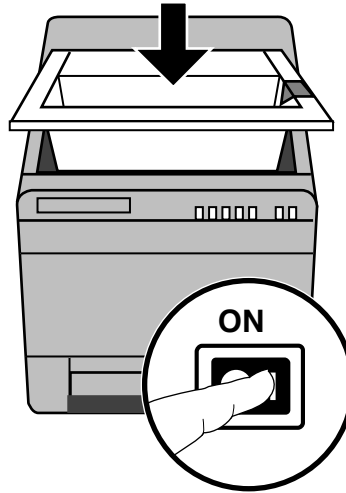

**Caution**

*The thermal head may be hot. To avoid possible injury, let it cool before cleaning it.*

- Use the wipe to gently clean the entire surface of the thermal head. Cleaning in one direction only prevents dirt from being re-introduced to the thermal head.

- Close the top cover. Turn on the printer using the switch at the side.



*Paper-feed Rollers – Clean every transfer roll change.*

□  
□  
1

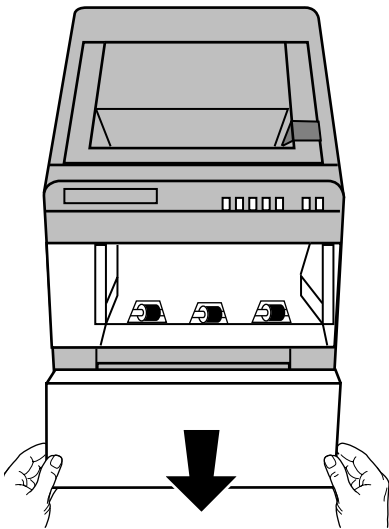

- Remove the front cover by pulling forward, using the fingerrips at each side.

2

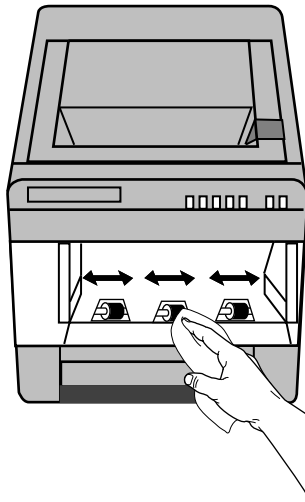

- Clean the three paper-feed rollers; rotate them as you wipe so that all surfaces are cleaned.

□  
□

3

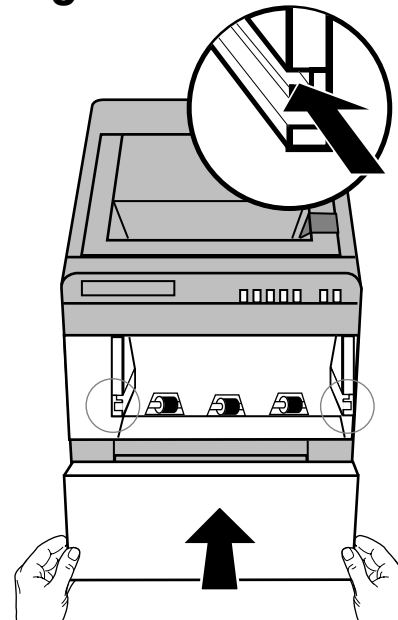

- Replace the front cover, tilting it slightly toward you to align the guide-tabs in the top slot.

Paper-pick Rollers – Clean every transfer roll change.



1

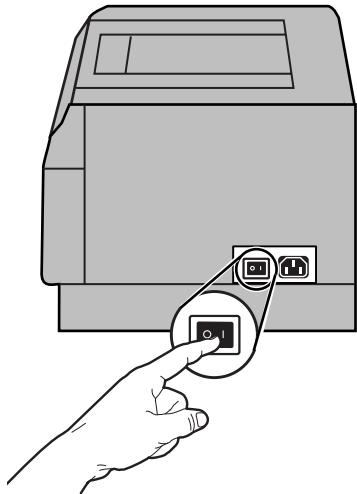

- Turn off the printer.

2

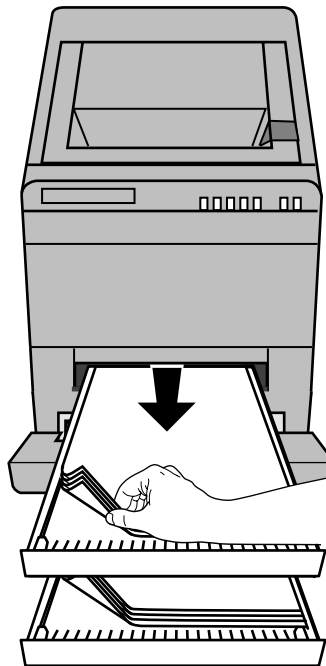

- Remove the paper tray. Remove the paper or transparencies from the tray. If your printer has two paper trays, be sure to remove both trays.
- When removing paper or transparencies, do *not* push the paper tray's metal plate down. If the metal plate is down, put the paper tray in the printer and pull it out again; this returns the metal plate to the *up* position.

3

For A4-size (metric) trays

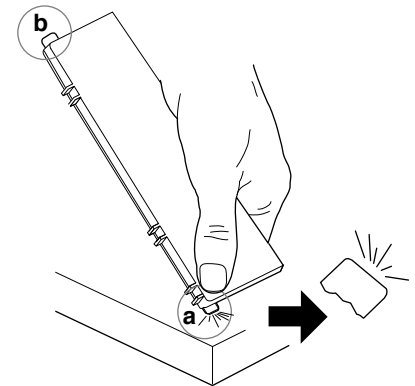

- Remove the cleaning tray from your cleaning kit.

**Note**

*If you are using an A-size (U.S.) paper tray: do not break the endtabs off the cleaning tray. Proceed to Step 4 on the following page.*

- **If you are using an A4-size (metric) paper tray:** break both endtabs (a and b) off the cleaning tray.

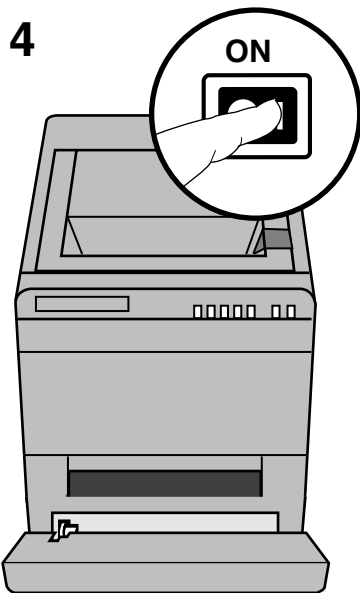

- Turn on the printer. Wait 30 seconds until the **READY** light is on.

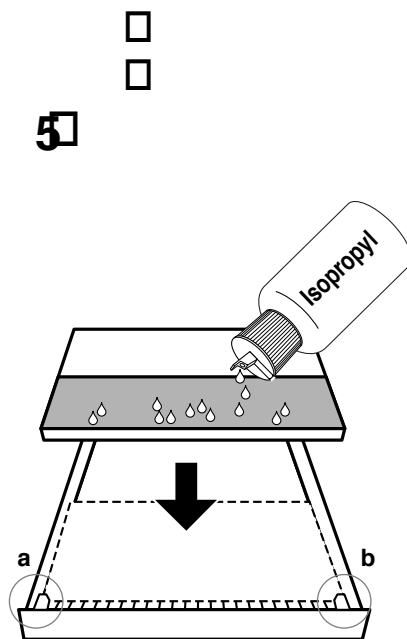

- Open the cleaning tray. Dampen the pad on the cleaning tray with isopropyl alcohol. Dampen the entire surface but do not saturate it.
- Slide the cleaning tray into the paper tray. Position the cleaning tray gently, so that the paper tray's metal plate presses up, against the cleaning tray. Be sure that the corners or endtabs of the cleaning tray are secured under the hooks on the paper tray (a and b).

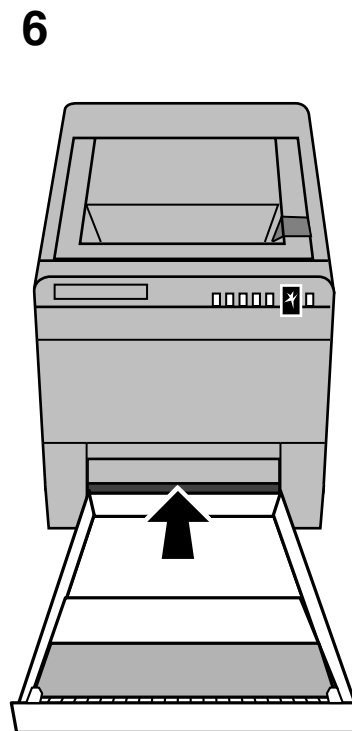

- Insert the paper tray containing the cleaning tray into the printer. If your printer uses two paper trays, load the *lowest* tray opening *first*.

□  
□

7

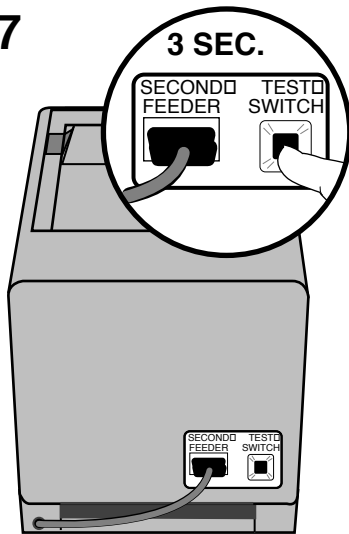

- Press and hold the **TEST** switch for 3 seconds; the switch is at the back of the printer.

□  
□

□

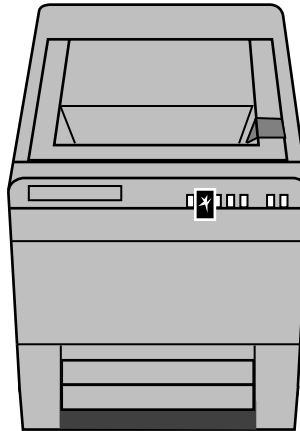

8

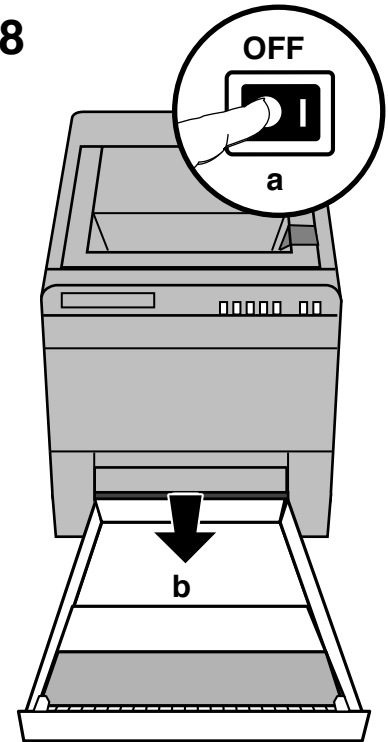

**Note**

*When the **JAM** light blinks you have completed cleaning this set of paper-pick rollers.*

- Turn off the printer (a). Remove the paper tray containing the cleaning tray (b).
- **If your printer has only one paper tray:** remove the paper tray from the printer and the cleaning tray from the paper tray. Reload the paper tray with paper or transparencies and replace it in the printer.
- **If your printer has two paper trays:** proceed to Step 8 to clean your printer's second set of paper-pick rollers.

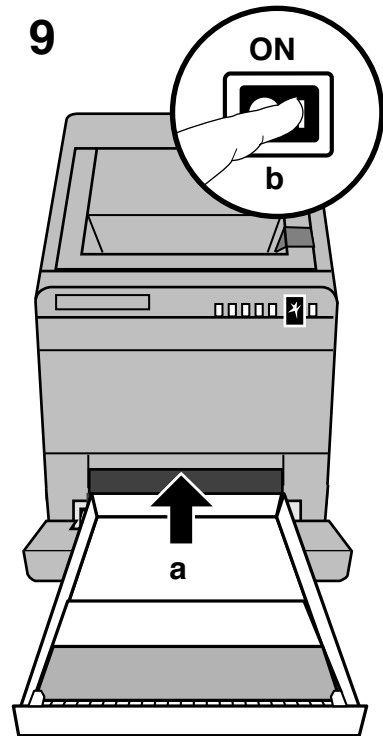

- Insert the paper tray containing the cleaning tray into the upper opening (a). Turn on the printer (b). (Turning your printer off and on resets the printer default to the upper tray and lets you clean this set of paper-pick rollers.)

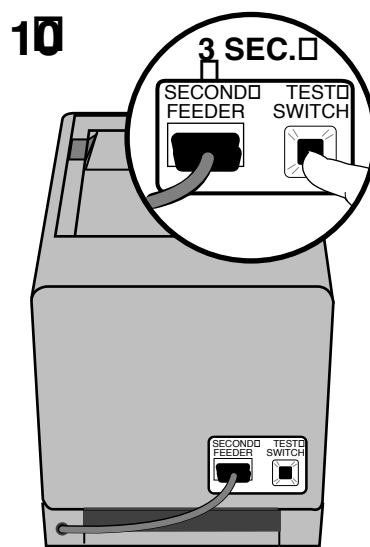

- Press and hold the **TEST** switch for 3 seconds; the switch is at the back of the printer.

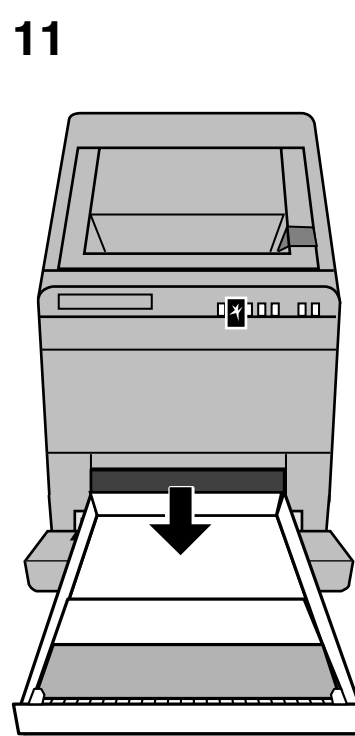

- When the **JAM** light blinks you have completed cleaning the second set of paper-pick rollers.
- Remove the paper tray containing the cleaning tray. Reload both paper trays with paper or transparencies and replace them in the printer.

□ *Transfer Roll Sensor Pad – Clean every 5,000 prints.* □

□

1

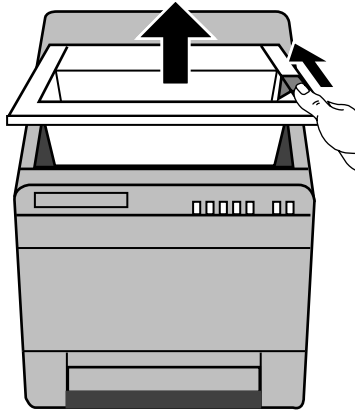

2

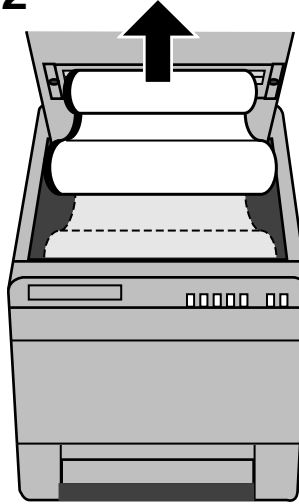

3

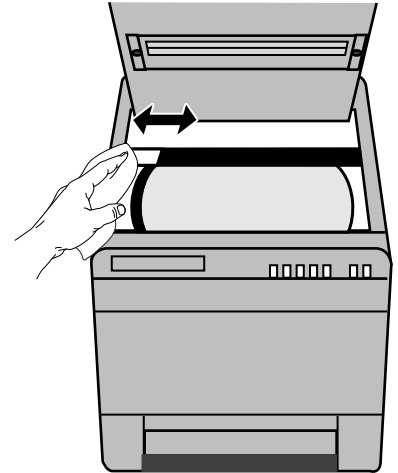

□ Open the top cover.

□ Remove the transfer roll from the printer.

□ Open a pre-saturated cleaning wipe packet and remove the wipe *or* dampen a lint-free wipe with isopropyl alcohol.

□ Use the wipe to clean the transfer roll sensor pad.

Drum – Clean every 5,000 prints. □

□  
□  
1  
□



2

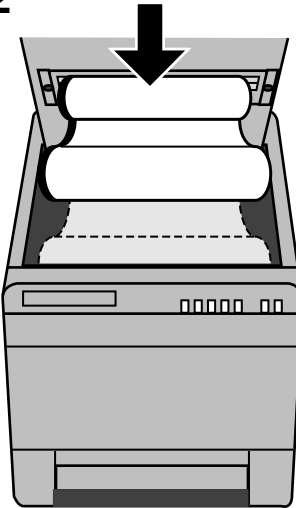

3

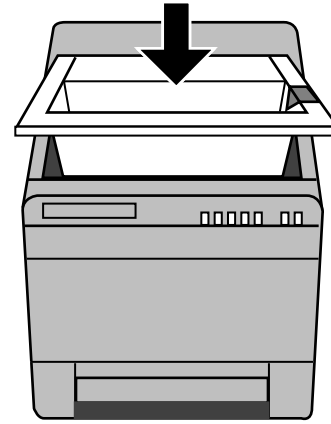

□ Clean the drum. Rotate the drum as you wipe so that the entire surface is cleaned.

□ Replace the transfer roll in the printer.

□ Close the top cover.

Exit Rollers – Clean every 5,000 prints. □

□  
□1  
□

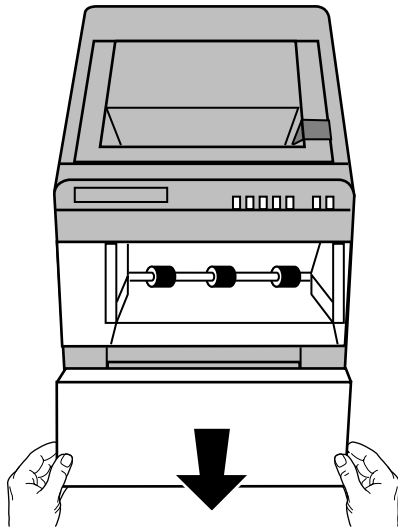

□ Remove the front cover.

2

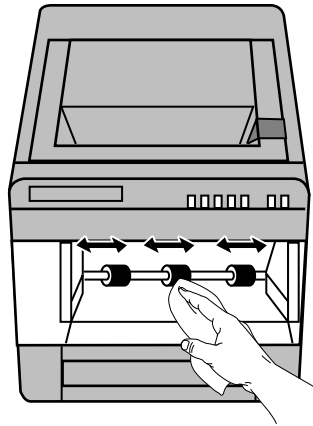

□ Clean the exit rollers; rotate them as you wipe, so that all surfaces are cleaned.

3

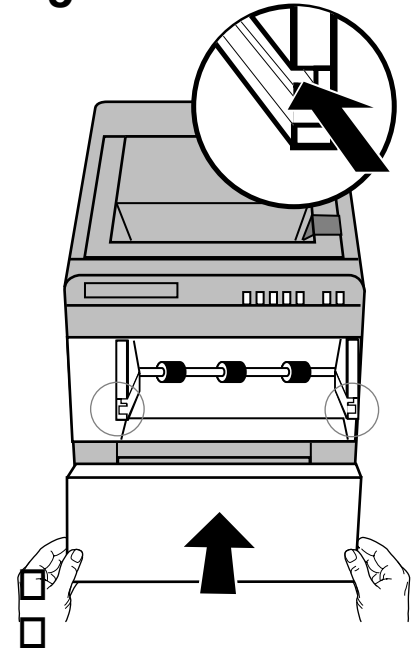

□ Replace the front cover, tilting it slightly toward you as you align the guide-tabs in the top slot.



February 1995

063-1450-02